

# Setra Room Isolation Monitor SRIM Installation and Operation Manual



[www.setra.com/srim2/](http://www.setra.com/srim2/)

This manual is available on the setra.com website and can be accessed directly by scanning the QR bar code above or the QR code on the unit or box labels.

The Setra logo, featuring the word "setra" in a stylized, lowercase font where each letter is composed of vertical blue and white stripes.



# **TABLE OF CONTENTS**

- 1.0 Features and Intended Use
- 2.0 SRIM Included parts
- 3.0 Installation
- 4.0 Menu Navigation and Configuration

## 1.0 FEATURES

The SRIM1 has a non backlit LCD display and alarms on pressure. It is capable of true 2 wire 4-20 mA loop powered operation.

The SRIM2 is a 3 wire has a 3 color backlight, a digital input for a door switch, 2 analog inputs for temperature and humidity and 1 relay output for remote alarm indication. It can alarm on Pressure, temperature and humidity parameters.

### Monitor Room Parameters

- Room Pressure
- Temperature
- Humidity
- Door status (Open or closed)

### User Interface

- Large LCD 2 line display, Room Pressure, Temperature (Optional) and Humidity (Optional) as well as room status indication.
- Green (Normal), Yellow (Warning), Red (Alarm) Backlit display for indicating the room status for SRIM2, Monochrome for SRIM1
- Membrane keypad for ease of configuration and menu navigation.
- Password Protection for security.

### Audible Visual and Remote Alarms

- Color Backlight LEDs.
- Alarm on Pressure, temperature and humidity
- Audible Buzzer.
- Alarm delay, mute timeout, alarm enable/disable, buzzer enable/disable
- SPDT Relay for remote alarms, including Setra Remote Annunciator (SRAN).

### Ease of Installation Use and Calibration

- Flush mount and duct mount versions, both wipe down for decontamination.
- Rotate-able pressure fittings to eliminate crimping of pressures hoses, allows installation flexibility.
- Snap on cover, no visible fasteners.
- Modular Plug in design using sub-base. Simultaneous Electrical and plumbing connections reduce initial installation and calibration costs. Unit can be calibrated in house or sent to Calibration service without removing the wiring or plumbing.
- Push button zero and span calibration, no potentiometer adjustments.
- PG9 and Conduit fitting in same unit, field selectable.

### Versatile

- Field selectable outputs, 4-20 ma. 0-5 VDC and 0-10 VDC
- Uni Directional or Bi Directional Ranges, field selectable

## Intended Use

The Setra SRIM Room Isolation Pressure Monitor is designed for critical low differential pressure applications that require stringent pressure monitoring and alarming. The SRIM can be configured to monitor positive, negative or neutral pressures in protected environments. The SRIM is a complete system that includes a 2 line LCD display with large characters for the pressure, temperature and humidity indication and room status. The membrane keypad user interface enables access to setup, security, calibration, and alarm setups. Backlight LED's (SRIM2) provide a local visual indication of the room pressure alarm status and a local audible alarm (with time delay feature) alert personnel to system status. Analog outputs are available in 4-20 mA, 0-5 or 0-10 VDC in the same unit. True differential pressure is displayed with a resolution of up to .0001" as well as the room status. Setra's patented very low pressure capacitance sensor is dead ended and avoids the potential for cross contamination of the room and reference space as well as eliminating drift that results from fouling of flow based sensors, which by nature have a flow path connecting the protected and reference spaces.

## 2.0 SRIM INCLUDED PARTS



Fig. 2-1 Parts

The SRIM parts list includes

SRIM Isolation Room Monitor

Electrical Plugs for 1/2" conduit or PG9 strain relief connector.

RPS pressure taps 0, 1 or 2 as ordered, including mounting screws. The RPS is mounted to a single gang box. One is typically located in the isolation room and the second is mounted in a corridor (reference pressure). The back of the RPS has a barbed fitting for plastic tubing to be connected to the SRIM.



Fig. 2-2 RPS Pressure taps

### 3.0 INSTALLATION

The SRIM is available in two models suitable for wall (flush mount) and surface mounting (or panel mounting). The front panel of the product and product rear housing are snapped together, the two snaps are located on the left and right sides of the front panel. A 1.5mm (1/16 inch) Allen wrench or paper clip can be used to open the concealed snap fastening system.

The rear housing can be used to mount to a wall or into a 3 gang “off the shelf” electrical box. Conduit (1/2”) or a PG9 cable connection are available for wiring to the terminals at the rear of the unit. The rear housing acts much like a sub-base that does not have to be removed once installed.

The front bezel contains the pressure sensor, PCBA and display. It is a complete module that can be calibrated. The pressure and electrical connectors are disconnected simultaneously when the front bezel is removed.

Before installing determine a good installation location. For Flush mount applications, the corridor outside the isolation room is preferred. For Surface mount applications the unit may be mounted on the duct work (avoid high vibration), a stable surface near the ductwork or inside a panel.

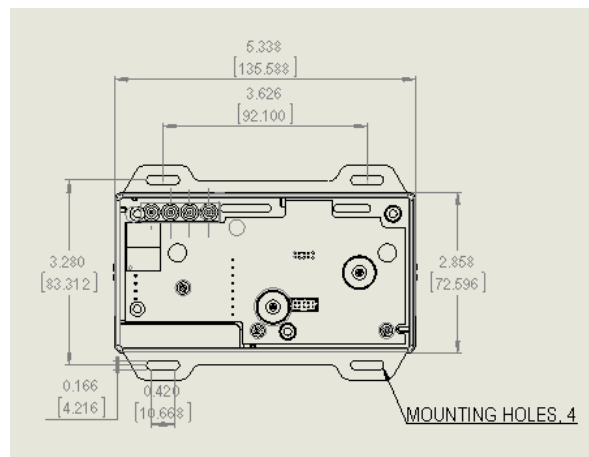

Fig 3-1 Wall (Flush) mount housing dimensions, front view, SRIM1,2

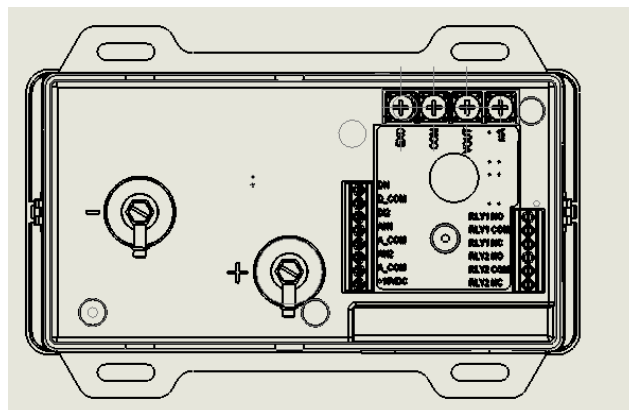

Fig 3-2 SRIM2 Wall (Flush) mount housing rear view of pressure fittings and electrical terminations

Unpack the product box. Do not remove the protective film on the front panel until after installation to prevent scratching of the display during the installation process. Remove parts and place them on flat surface. Apply pressure on the side of the box to open the snap fit or use an allen wrench or paper clip as shown See Figure 1-2. First one side then the other, then pull the bezel forward to remove it from the housing.



Fig. 3-3 Removing bezel from the base

### Plumbing and Wiring to the Electrical Box (Rough in)

#### Flush mounting:

Use a 3 gang electrical box RACO 697 or equivalent or mount directly into the wall. If mounting directly into the wall create an opening approximately 2.8" (71 mm) by 5.4" (134 mm). If using the 3 gang box use #6 machine screws to mount the ears of the SRIM rear housing to the electrical box. If mounting directly into the wall without an electrical box, use drywall screws to mount the 4 ears of the SRIM box to the wall.

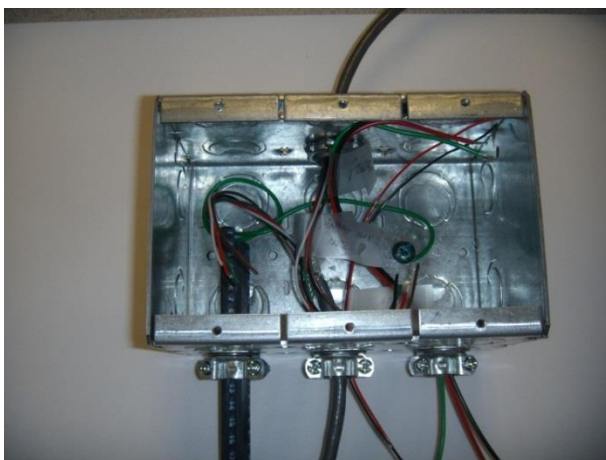

Fig. 3-4 Rough Plumbing and Wiring to Rough-in box, Flush Mount Unit

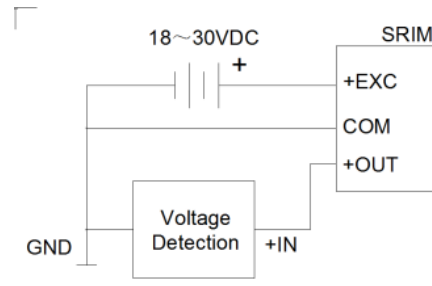
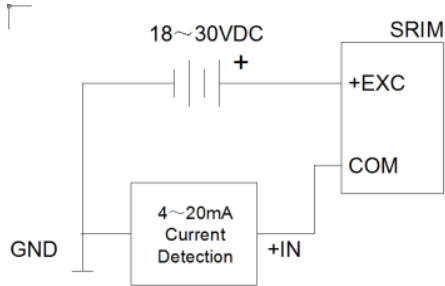
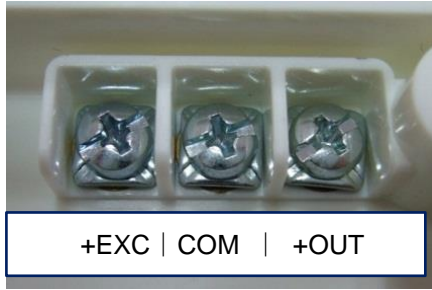

Fig. 3-5 Wiring Diagram SRIM1 and Back of unit

Rotating pressure Fittings, can point up or down, SRIM2 only

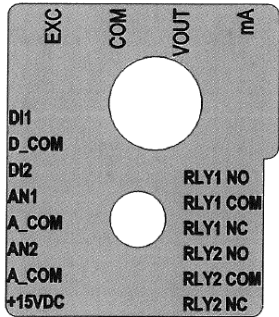
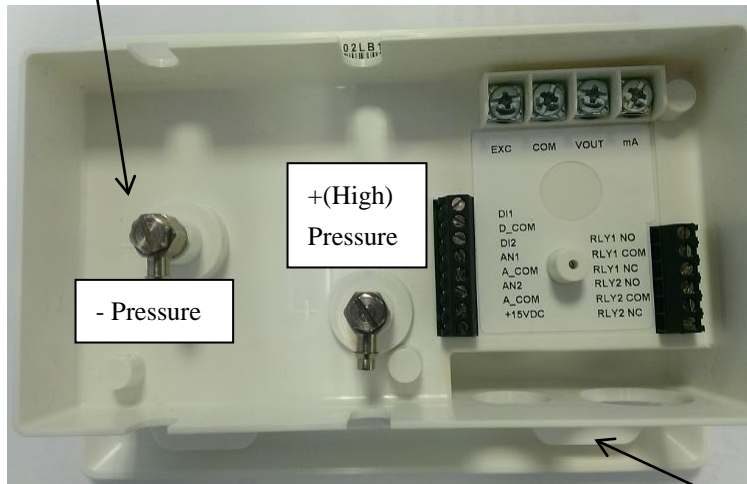

Fig 3-6 Pressure ports and electrical terminals. SRIM2

Pull wires through the openings in the bottom of the base. 1/2" Conduit or PG9 fitting openings are provided.

<b>Terminal</b>	<b>Function</b>
EXC	+24 VDC supply
COM	Power Supply COM and Analog Out COM
VOUT	Analog Output + (VDC mode)
mA	Analog Output (mA output mode)
D1	Door status, wire to one side of NO contact
D_COM	Door status, wire to other side of NO contact
DI2	Not used
AN1	+ output of temperature sensor (if used)
A_COM	Common output of temperature and humidity sensors (if used)
AN2	+ output of humidity sensor (if used)
COM	15V Power Common (return)
+15VDC	Power for remote annunciator (if used)
RLY1 NO	Relay 1 Normally open contact
RLY1 COM	Relay 1 Common contact
RLY1 NC	Relay 1 Normally closed contact
RLY1 NO	Not used
RLY1 COM	Not used
RLY1 NC	Not used

Table 1 Wiring SRIM2



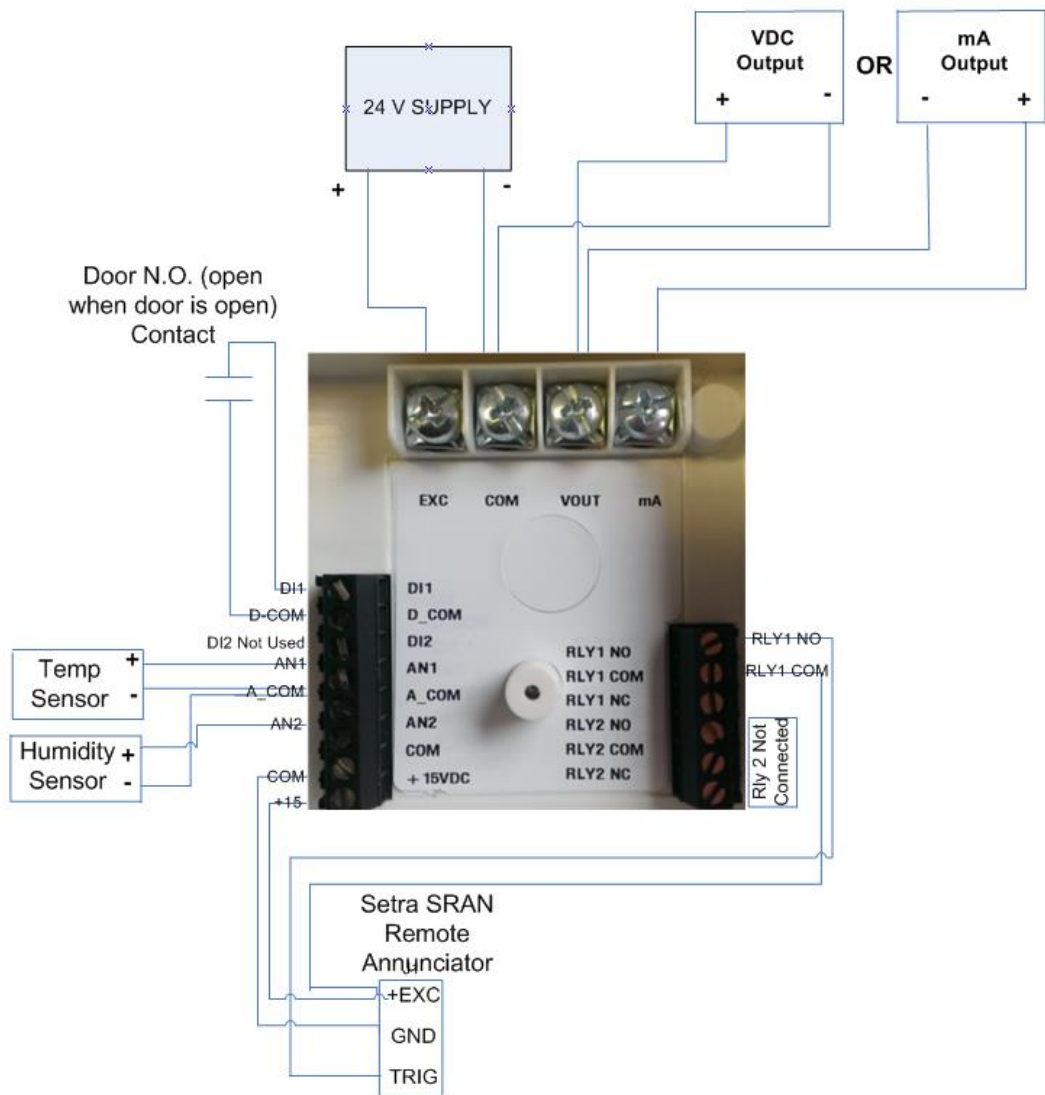

Figure 3-7 Wiring, SRIM2

Notes:

Relay 1 (RLY1) is a SPDT relay that can be used to signal a remote unit of an alarm condition. The relay contacts are rated for 3 A, 120 VAC.



Fig. 3-8 Installed plugs on unused openings in the base.

Connect the pressure tubes to the high and low pressure ports. Wire to the electrical terminals on the back of the housing. If desired, place electrical plugs on the unused holes in the base

Complete the installation by installing the bezel onto the base by aligning the two and pushing the bezel into the base until the bezel snaps to the base on the 2 sides. Be sure to carefully align the 2 parts and push straight in. There are alignment features on the front bezel and rear housing.

#### 4. 0 MENU NAVIGATION AND CONFIGURATION

The LCD display is standard on all SRIM products, the display provides valuable feedback during configuration and for user feedback in the normal and alarm modes.

The SRIM1 has a non backlit LCD display and alarms on pressure

The SRIM2 has a 3 color backlight, a digital input for a door switch, 2 analog inputs for temperature and humidity and 1 relay output for remote alarm indication. It can alarm on Pressure, temperature and humidity parameters.

Apply 24 VDC power.

The display goes through the initialization sequence, the LCD screens will be displayed in the following order.

Software version information.

Product pressure range, in “WC or Pascal.

Analog output mode, 4-20, 0-5 or 0-10 VDC.



Unit in the normal state, line 1 is the indicated differential pressure and units. Line 2 indicates the temperature and humidity reading, if enabled. The green backlight indicates that the room pressure, the temperature and humidity is within the allowable alarm limits. Note that the alarm will occur if any of the 3 monitored parameters are outside of their respective limits.



Unit in the alarm state. Red backlight, arrow indicating which parameter and if it above or below alarm limits and audible buzzer if enabled.

## Menu Operation



Menu key – Provides access to the menu structure



Down arrow key – Allows selection of numerical parameters. Pushing the down arrow cause the digits to move upwards in 1 digit count and will wrap around. The cursor below the indicated item in the current menu item indicates that this is the digit that is being changed. If you don't need to make a change to that position press the enter key to move to the next position to the right.



Enter key – Use this key to move left to right in a current menu screen, also used to save the current menu item selected settings, or the confirm current menu operation; press the Enter key to save the current settings, the display shows the current setting value and flashes twice, and to prompt the user that the currently set value has been saved.



Return/Silence button – This button provides a quick way to return to the home screen from anywhere within the menu structure. It has the secondary purpose of temporarily silencing the audible alarm. If the mute timeout setting is reached the audible will again sound.

Menu items, in the order that they appear in the menu. These are placed in order of the anticipated most used functions near the top of the menu tree. It is suggested that in the initial configuration that the user progress through each section in order.

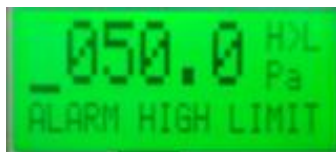

### ALARM HIGH LIMIT

Sets the high pressure alarm limit, the high pressure limit must be greater than the low pressure limit



### ALARM LOW LIMIT

Sets the low pressure alarm limit



### ALARM DELAY

Sets the delay (sec) between the time that the alarm high or low limits are exceeded and when the alarm is indicated



#### MUTE TIMEOUT

Sets the time delay (sec) between when the buzzer mute button is pressed and when it will re-sound if the pressure is still out of range



#### ALARM ENABLE

Enables the audible and visual alarms indicators

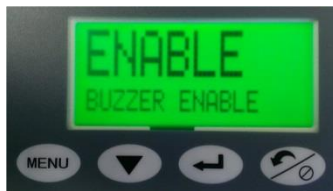

#### BUZZER ENABLE

Enables the local audible buzzer



#### OUTPUT MODE

Sets the analog output mode, 4-20 ma, 0-5 VDC or 0-10 VDC



#### PRESSURE MODE

Sets the unit into uni-directional or bi-directional pressure modes, ex: +/-0.25" or 0-0.25"WC



#### FILTER SETTING

(1-99), default is 10. Sets up a data averaging filter, the lowest numbers provide the fastest output response but highest analog output noise. In an extremely pressure noisy environment use higher numbers until the pressure display flickering is reduced.



#### DOOR SWITCH FUNC

Only Available on SRIM2. Door switch enable/disable. Enable if used with a door switch to detect if door is open.



### PASSWORD ADMIN

Enables or disables the 4 digit numeric password, use backdoor password 0159, if the password is lost



### ZERO CALIBRATION

“Tares” out any 0 pressure error. This must be done with 0 pressure applied.



### SPAN CALIBRATION

“Tares” out any Span pressure error. This must be done with the +Full Range (FR) pressure applied. For ex: if the pressure range is +/-0.1” WC, apply 0.1” WC.



### RESUME CAL VALUE

Restores factory calibration settings in case a calibration may have been performed incorrectly

The Temperature and Humidity Functions and alarming are only available on the SRIM2.



#### TEMPERATURE FUNC

Temperature Function, pressing the enter key will drop down into the setup of the external sensor for AN1 (Analog input 1). Press menu button to move between items in this menu.



#### TEMP ENABLE

Pressing the down arrow toggles between enable and disable. Press enter key to select enable/disable.

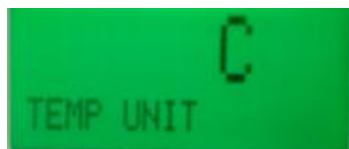

#### TEMP UNIT

Pressing the down arrow toggles between Degrees C or F. Press Enter key to select F/C



#### T\_Min Vin

Input the analog output of the temperature sensor corresponding lowest temperature to be measured  
T\_Min T. Ex: 0 V = 50 F.

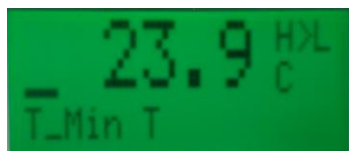

#### T\_Min T

Input the minimum temperature that corresponds to the min. analog output T\_Min Vin

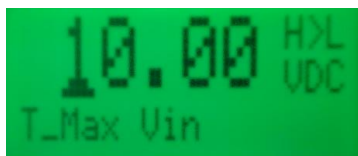

#### T\_Max Vin

Input the analog output of the temperature sensor corresponding lowest temperature to be measured  
T\_Max T. Ex: 0 V = 50 F.



#### T\_Max T

Input the maximum temperature that corresponds to the max. analog output T\_Max Vin



#### T\_ALARM L LIMIT

Set the low temperature alarm limit in Degrees C or Degrees F



#### T\_ALARM H LIMIT

Set the high temperature alarm limit in Degrees C or Degrees F



#### T\_ALARM ENABLE

Enable or disable the Temperature alarms by using the down arrow to toggle between selections, Press Return key to accept

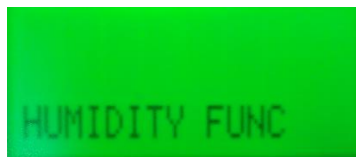

#### HUMIDITY FUNC

Humidity Function, pressing the enter key will drop down into the setup of the external sensor for AN2 (Analog input 2)



#### HUMIDITY ENABLE

Pressing the down arrow toggles between enable and disable.



#### H\_Min Vin

Input the analog output of the humidity sensor corresponding lowest humidity to be measured H\_Min  
T. Ex: 0 V = 0%RH

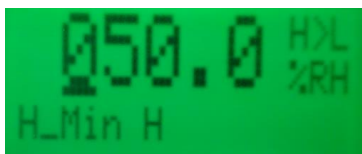

#### H\_Min H

Input the minimum humidity that corresponds to the min. analog





H\_Max Vin  
Input the analog output of the humidity sensor corresponding

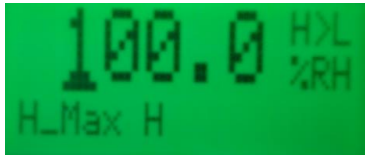

H\_Max H  
Input the maximum humidity that corresponds to the max. analog



H\_ALARM ENABLE  
Enable or disable the Humidity alarms by using the down arrow to toggle between selections, Press Return key to accept selection



RETURN  
Returns from the configuration mode to the normal operating mode

### Example 1: Output mode setting

To enter the menu, press the Menu key. Continue pressing until the display indicates output mode. 4-20 mA is the default output mode, if you want to change to 0-5 or 0-10 press the down arrow and press the return key to select. The display will blink 2X to confirm the setting change.

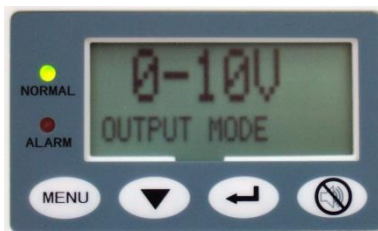
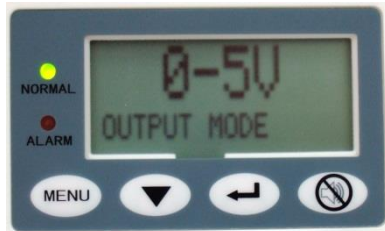

Continue to press the menu key to progress all the way through the menu until you reach the RETURN screen. Press the Enter key to exit out of the menu and return to home screen.

### Example 2: Setting the password (4 digit numerical) protection

Press the down key to select the menu item PASSWORD ADMIN, the system will prompt to input the password, when the input is complete press the Enter key to save the password and complete the setup. When password protection is enabled, you must enter the correct password before you can enter the menu the view or change parameters.

Save the password in a safe location. If you forget the password, use the backdoor password of 0159 and reset the password if desired.



### Example 3: Calibration

Remove the pressure ports or shut of fans to the room and open the door so that zero differential pressure is applied to the monitor.

Select menu items ZERO CALIBRATION, the display shows the current pressure value, press the Enter key. If the reading is within allowed limits the unit will respond with the message that calibration was successful.

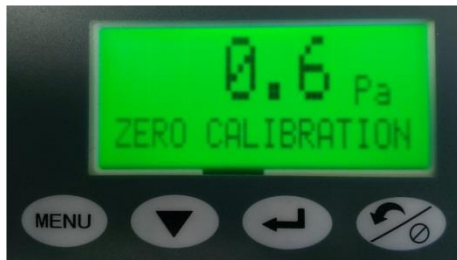

Full scale calibration:

Note: the full range adjustment should be completed after zero adjustment.

Span adjustment should only be performed if a very accurate and stable Full Range pressure can be applied, such as with a Setra Model 869 Calibrator.

Apply full range pressure to the high and low pressure ports.

Select menu items SPAN CALIBRATION, the display will show the current pressure value, press the Enter key, if the applied pressure is within allowed limits then the unit respond that span calibration has been successful .



## RETURNING PRODUCTS FOR REPAIR

When returning a product to Setra Systems, the material should be carefully packaged and shipped prepaid to: Setra Systems, Inc.

To assure prompt handling, please refer to return instructions on our Web site at [http://www.setra.com/repairs/cal\\_rep.htm](http://www.setra.com/repairs/cal_rep.htm).

### WARRANTY AND LIMITATION OF LIABILITY

SETRA warrants its products to be free from defects in materials and workmanship, subject to the following terms and conditions: Without charge, SETRA will repair or replace products found to be defective in materials or workmanship within the warranty period; provided that:

- a) the product has not been subjected to abuse, neglect, accident, incorrect wiring not our own, improper installation or servicing, or use in violation of instructions furnished by SETRA;
- b) the product has not been repaired or altered by anyone except SETRA or its authorized service agencies;
- c) the serial number or date code has not been removed, defaced, or otherwise changed; and
- d) examination discloses, in the judgment of SETRA, the defect in materials or workmanship developed under normal installation, use and service;
- e) SETRA is notified in advance of and the product is returned to SETRA transportation prepaid.

Unless otherwise specified in a manual or warranty card, or agreed to in writing and signed by a SETRA officer, SETRA pressure, humidity, and acceleration products shall be warranted for one year from date of sale.

The foregoing warranty is in lieu of all warranties, express, implied or statutory, including but not limited to, any implied warranty of merchantability for a particular purpose.

SETRA's liability for breach of warranty is limited to repair or replacement, or if the goods cannot be repaired or replaced, to a refund of the purchase price. In no instance shall SETRA be liable for incidental or consequential damages arising from a breach of warranty, or from the use or installation of its products. No representative or person is authorized to give any warranty other than as set out above or to assume for SETRA any other liability in connection with the sale of its products.

For all CE technical questions, contact Setra Systems, USA. EU customers may contact our EU representative Hengstler GmbH, Uhlandstr 49, 78554 Aldingen, Germany (Tel: +49-7424-890; Fax: +49-7424-89500).



159 Swanson Road, Boxborough, MA 01719-1304

Tel: 800-257-3872/978-263-1400

Email: [sales@setra.com](mailto:sales@setra.com); Web: [www.setra.com](http://www.setra.com)